



APPLICATION

- Servomotors are designed for adjusting control elements (e.g. valves), for which their properties are suitable.

DESCRIPTION

Servomotors are direct, tie-rod, with constant control speed of adjustment of the outlet part. The reversing asynchronous motor and self-locking gear mechanism are stored in the box with removable lid. Conductors are brought in through sealing outlets. The outlet tie-rod is ended with a coupling for connecting with a valve. The design is solved so that the connection elements can be attached pursuant to the design of the relevant valve (flange, columns, etc.).

The control can be ensured either with a three-point connection or position control, signal 0 to 1V, 0 to 10 V, 0 to 20 mA and 4 to 20 mA. It transfers the inlet analogue signal to the corresponding position of the servomotor. The position is sensed by the resistance transmitter. It can be completed with a sensor for checking maximum temperature of the motor, which trips it and activates signalling after the maximum pre-set value has been exceeded. The inlet signal can be changed with interconnected pieces, limit positions can be adjusted by means of push-buttons or by means of a computer. It can also be used for adjusting the upper and the lower insensitivity zones, changing the course of movement of the servomotor with respect to the inlet signal (e.g. linear, quadratic, logarithmic or user-defined in 100 points), type of operation of the controls in case of exceeding the adjusted range by 5 % (open, close, without response, movement to the end position in the direction of the signal).

In addition to strength switches, position indicators, thermal fuse of the driving motor and manual control, they can be equipped with:

- two signalling switches, adjustable within the whole range of the operation lift;
- resistance position transmitter 100 Ω (one or two);
- resistance position transmitter with signal converter 4 to 20 mA for two-wire connection to measuring loop (power supply directly from measured signal);
- capacity position transmitter CPT1 / A - signal 4 to 20 mA, double wire (power supply from auxiliary source);
- heating resistor.

TECHNICAL DATA

The servomotor is designed pursuant to ČSN EN 61010-1 as an electrical equipment of protection class I for the application in networks with the category of overvoltage in the installation II (for AC 230 V) and overvoltage in the installation III (for AC 24 V) and pollution grade 2.

The servomotor has internal and external protective clamps, which are mutually interconnected.

The servomotor has no fuse of mains power supply and it shall be secured with an external fuse pursuant to ČSN EN 60127-2 ed. 2.

Electrical strength

Servomotor with supply voltage AC 230 V:

- Circuit of power supply and signalling switches against protective clamp: AC 1500 V
- Circuit of power supply and signalling switches against transmitter circuit: AC 2300 V
- Circuit of transmitter against protective clamp: AC 500 V

Servomotor with supply voltage AC 24 V:

- Circuit of power supply and signalling switches against transmitter circuit: AC 740 V
- Circuit of power supply and signalling switches against protective clamp: AC 500 V
- Circuit of transmitter against protective clamp: AC 500 V

Electrical insulation resistor: min. 20 M Ω

Power supply

Type of supply mains: 1 / N / PE AC 230 V, 50 Hz or AC 24 V, 50 Hz

Supply voltage tolerance: $\pm 10\%$

Mains frequency tolerance: 48 to 52 Hz

Power input: 99 VA
heating resistor 15 W

The motor is protected against overload with a thermal fuse, which trips after the temperature of approx. $130 \pm 5^\circ\text{C}$ is reached.

Coverage pursuant to ČSN EN 60529: IP 65

Operation position:

Discretionary, the position with vertical axis of the outlet shaft is considered the basic one. However, positioning below the controlled equipment is not recommended.

Sensor weight: approx. 12.5 kg

OPERATION CONDITIONS

The environment is defined by the group of parameters and their severity grades IE 36 pursuant to ČSN EN 60721-3-3 and the following operation conditions.

Ambient temperature: -25 to 55°C

In the operation at temperatures below -15°C and in wet conditions, a resistor shall be connected, even if the servomotor is idle. The resistor is not a part of the equipment. The manufacturer shall be notified of such operation; it will ensure required modifications for a trouble-free operation of the machine.

Relative ambient humidity:

10 to 100 % with condensation, with upper level of water content 29 g H₂O/kg of dry air

Atmospheric pressure: 70 to 106 kPa

Vibrations:

- Frequency range [Hz] 10 to 150
- Drift amplitude [mm] 0.15
- Acceleration amplitude [$\text{m}\cdot\text{s}^{-2}$] 20

METROLOGICAL DATA

Accuracy of nominal strength: $\pm 10\%$

Accuracy of output part changeover speed: $\pm 10\%$

Operation life of servomotor: min. 12 mm, max. 65 mm

Minimum and maximum operation lift is limited by the operation lift of the valve. Strength switches switch off when the pre-set value of strength is achieved at any position within the operation lift.

Clearance of the output part with load 25 % of nominal strength: max. 0.3 mm

Time interval for reversing: min. 50 ms (without load)

Load factor: pursuant to ČSN EN 60034-1+A2+A1 ed.2

- interrupted action S4 - 60 %, 100 to 1200 cycles / hour
- short-term action S2 - 60 minutes

Hysteresis of signalling switches: max. 3°

Rating of position switches and signalling switches:

AC 250 V / 5A resistance load
3A inductive load

Parameters of resistance transmitter (related to max. lift):

- total resistance 100 $\Omega \pm 3\%$
- residue resistance in position "C" max. 10 Ω
- residue resistance in position "O" max. 10 Ω
- non-linearity max. $\pm 1\%$
- hysteresis max. 1 %
- rating max. 120 mA

Parameters of resistance transmitter with converter

4 to 20 mA (related to max. lift):

Power supply: DC 12 to 45 V from safe source PELV or SELV

Load resistor: $R_z = (U-12)/0.02$ [Ω]

Settlement period after switching on power supply: 30 min.

Output signal: 4 to 20 mA DC
20 to 4 mA DC

Ripple: max. 5 %

Non-linearity: max. $\pm 1\%$

Hysteresis: max. 1 %

Parameters of capacity transmitter with converter (related to max. lift):

- output signal 4 to 20 mA (or 20 to 4 mA)
- non-linearity max. $\pm 1\%$
- hysteresis max. 1 %
- rating max. 20 mA
- ripple max. 5 %
- power supply DC 15 to 28 V
- load resistor 500 Ω
- default set-up of transmitter sector 120°

Electronics has galvanic insulation from the case.

Parameters of position control (related to max. lift):

- power supply AC 230 V
AC 24 V
- inlet signal with maximum tolerance $\pm 5\%$
It can be changed by means of interconnecting pieces.
 - 0 to 1 V / 10 k Ω
 - 0 to 10 V / 100 k Ω
 - 0 to 20 mA / 100 Ω
 - 4 to 20 mA / 100 Ω
- outlet relay contact – 250 V, 1 A
- action in case of failure it goes to the end position in the direction of the signal (other possibilities: open, close, without response)
- switch-off time 150 s $\pm 10\%$ (2.5 min.) - possible adjustment 5 to 250 s
- operation restart after switching the device on and off
- upper insensitivity zone 2 % (possible adjustment 2 to 5 %)
- lower insensitivity zone 2 % (possible adjustment 2 to 5 %)
- course of movement linear

ELECTROMAGNETIC COMPATIBILITY (EMC)

pursuant to ČSN EN 61326-1

- Values of interference voltage, pursuant to ČSN EN 55011: class A, group 1
- Electrostatic discharges, pursuant to ČSN EN 61000-4-2: 4 kV contact, 8 kV by air, functional criterion 2
- External electromagnetic field, pursuant to ČSN EN 61000-4-3 ed. 2: 10 V/m 80-1000 MHz, 80% AM 1 kHz, functional criterion 1
- Fast transient phenomena, pursuant to ČSN EN 61000-4-4: 2 kV power supply, 1 kV Sig. I/O, functional criterion 2
- Surge impulse pursuant to ČSN EN 61000-4-5: 1 kV power supply symmetric and signal I/O, functional criterion 2
2 kV power supply non-symmetric, functional criterion 2
- Induced hf field pursuant to ČSN EN 61000-4-6: 3 V, 0.15 – 80 MHz, functional criterion 1
- Magnetic field of mains frequency, pursuant to ČSN EN 61000-4-8: 30 A /m, functional criterion 1
- Declines of power supply drops pursuant to ČSN EN 61000-4-11:

30 %, duration period 10 ms	functional criterion 1
60 %, duration period 100 ms	functional criterion 3
60 %, duration period 1000 ms	functional criterion 3
>95 %, duration period 5000 ms	functional criterion 3

DESIGNATION**Data on the servomotor label:**

- Trade mark of the manufacturer
- Made in Czech Republic
- Product number
- Manufacturing number
- Nominal voltage, frequency and power input
- Adjustment speed
- Nominal strength
- Nominal voltage and current of switches
- Coverage grade
- Weight
- Operation lift
- CE mark

The servomotor lid includes the connection scheme.

CERTIFICATION

- Compliance Certificate EC - 671000

DELIVERY

The servomotors are delivered with installed coupling for the connection to the tie-rod of the valve. The signalling switch SC is adjusted approx. 2 mm before the position "CLOSED" and signalling switch SO is adjusted approx. 2 mm before the position "OPEN" pursuant to the lift. Unless established otherwise, they are delivered with the lift 65 mm.

Every delivery includes, unless agreed otherwise with the customer:

- Delivery note
 - Products pursuant to the purchase order
 - Original technical documentation in Czech in the following range:
 - Product quality and completeness certificate (it declares compliance with Technical conditions and it also serves as the warranty certificate)
 - Installation, operation and maintenance manual
- If it is established in the purchase contract or agreed otherwise, the following documentation can be also delivered with the product
- EC Compliance certificate
 - Test report
 - Other documents

RELIABILITY

Medium service life is 6 years, however 3,000 operation cycles as a maximum for servomotors for remote control and 250,000 cycles of servomotors for automatic control with service time specified in technical documentation for any specific product.

PACKING

The products are packed pursuant to controlled packing regulations identified by a technological procedure for the relevant product. Servomotors are delivered in the packing ensuring resistance against the impacts of temperature effects pursuant to ČSN EN 60654-1 and mechanical effects pursuant to ČSN IEC 654-3.

TRANSPORT

The servomotors may be transported on conditions corresponding to the set of combinations of the classes IE 21 pursuant to ČSN EN 60721-3-2. The servomotors can be transported by rail or vehicles. In case of air transport, transport in heated and hermetically closed parts of the airplane shall only be considered.

STORAGE

The servomotors may be stored in the transport package on conditions corresponding to the set of combinations of classes IE 11 pursuant to ČSN EN 60721-3-1. The products may be stored for max. 12 months. After this period, control piece tests shall be realized pursuant to TP.

PLACING AN ORDER

The purchase order shall specify

- Name
- Product ordering number
- Specification (if there is any)
- Special design after an agreement with the manufacturer
- Number of pieces

PURCHASE ORDER EXAMPLE

Electric servomotor ZEPADYN 671
671 121 / OP1, S1, R1, ZD40
5 pcs

SERVOMOTOR DESIGN

SPECIFICATION		ORDERING NUMBER			
		671	x	x	x
Supply voltage AC	230 V, 50 / 60 Hz		1		
	24 V, 50 / 60 Hz		2		
Nominal strength [kN]	16			1	
	20			2	
Outlet part changeover speed [mm / min]	16				1
	25				2
	32				3
	50				4

Basic design: three-position position control, manual control, moment switches for positions O and C and end position switch, without transmitter and connecting elements.

ADDITIONAL ACCESSORIES

CODE	NAME	Connection pursuant to Fig. - Installation, operation and maintenance manual
OP1	position control 0 to 1 V, 0 to 10 V, 0(4) to 20 mA - without R2 and I1	
ANP1	adapter with adjusting programme for servomotors with OP1	
S1	signalling switches SO and SC	
R1	1 resistance transmitter 100 Ω	
R2	2 resistance transmitters 100 Ω - without OP1, I1, C1	
I1	converter 4 to 20 mA – without R2, C1	
C1	capacity transmitter CPT1 – without R2 a I1	
T1	heating resistor	
P2	pitch 150, M 20, M 20 × 1.5	Figure 1
P3	pitch 150, M 20, M 16 × 1.5	
P4	pitch 150, M 20, M 20 × 1.5	Figure 2
ZD	lift for valve - 12, 16, 20, 25, 32, 40, 52, 62 mm	

The specification code shall be identified behind the ordering number.

INSTALLATION AND CONNECTION

The servomotor shall be connected to the controlled equipment by means of a flange or columns. The type of connection is evident in the dimensional drawings 1 and 2.

Connection of the servomotor to the controlled equipment

Design P2 pursuant to Figure 1:

Adapters of columns are screwed into the flange of the valves. Columns of servomotors are inserted into the adapters and cap nuts are tightened.

Design P3 pursuant to Figure 1:

Adapters of columns are screwed into the flange of the valves. Columns of servomotors are inserted into the adapters and cap nuts are tightened.

Design P4 pursuant to Figure 2:

Adapters of columns are screwed into the flange of the valves. Columns of servomotors are inserted into the adapters and cap nuts are tightened.

Servomotor adjustment

By means of the manual control, tie-rod of the servomotor is adjusted approx. 2 mm before the stop columns in the position CLOSED. Press the tie-rod of the valve to the position CLOSED, too.

The valve spindle is screwed into the coupling and secured with a nut. By means of the manual control, move to the valve seat repeatedly in order to verify if the moment switch switches off with respect to valve seat and not to stop columns.

The lid of the servomotor is removed after releasing two nuts. After removing the lid, the terminal board is accessible for the connection of supply voltage, signalling switches and resistance position transmitter or converter 4 to 20 mA.

The servomotor is connected to supply voltage after mechanical connection to the controlled equipment and after the adjustment.

The connection is realized with the use of insulated Cu wires with max. cross section 1.5 mm², with total insulation resistance min. 10 MΩ and max. Ø of wire 12 mm. The servomotor has not own switch of mains power supply. The installation of the servomotor shall include a switch or a circuit breaker located close to the equipment, which enables disconnecting the device from supply mains. The connection scheme is illustrated in Figures 3 and 4.

The servomotor has not any fuse of mains supply and shall be secured with an external fuse pursuant to ČSN EN 60127-2 ed. 2.

The output shaft is adjusted:

By means of the wheel of manual control. Slide out the lever from the bottom of the box and turn it by 90°. The pin that is located there will ensure disconnecting the gearing. Push the manual wheel into the box. Before setting in automatic operation, slide the manual wheel out and return the pin at the bottom of the box to the groove.

Adjustment of the end position switch

The switch KPO is adjusted to the required lift after releasing the screws M2 by sliding inside the groove so that it trips at the required lift.

Adjustment of signalling switches

The servomotor is adjusted gradually to the positions to be signalled. By moving inside the groove, after releasing the screw M2, ensure switching of the relevant switches.

Adjustment of transmitter

The transmitter is adjusted by the manufacturer to the lift pursuant to the purchase order (62 mm unless specified otherwise).

If another lift is selected, perform the adjustment as follows:

- Move the bar with movement screw to the position CLOSED (distance 2 mm from the stop of the upper beam).

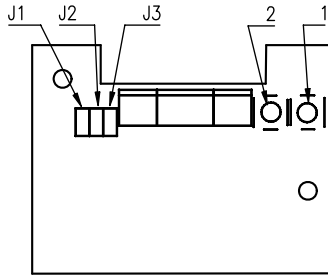

- Release screws M4 connecting the angle bar with transmitter, replace the toothed double-wheel determining the lift (it is delivered by the manufacturing plant), move it to ensure engagement with toothed comb and tighten the screws.
- Check the value of residue resistance; if it does not comply with the Installation, operation and maintenance manual, adjust it by turning the shaft of the potentiometer.
- Move the tie-rod to the position OPEN and inspect the value of residue resistance pursuant to preceding Article.

Wires of the transmitter circuit between the outlet and the terminal board shall be inserted into a PVC tube.

Adjustment of resistance transmitter with converter 4 to 20 mA

The converter is adjusted by the manufacturer to the lift pursuant to the purchase order. When changing the positions "C" and "O", follow the procedure described below:

Adjust the transmitter pursuant to the paragraph about the transmitter adjustment.

Connect milliammeter with accuracy 0.2 to the outlet from the sensor. After connecting supply voltage, allow temperature settlement of the sensor. After the settlement, the outlet current shall be 4 mA ± 80µA at the beginning of the shaft position and 20 mA ± 80µA at the end. Otherwise, adjust the initial and end positions of the shaft gradually and the corresponding currents 4 and 20 mA with trimmers; it is necessary to consider the fact that values influence each other. Repeat the adjustment until current at the beginning of the shaft position is 4 mA ± 80 µA and 20 mA ± 80 µA at the end or measure the current value at initial (I_{L0}) and end (I_{H0}) rotations of the shaft and calculate the new value I_{H1} for the end adjustment with the use of the formula (*). After the adjustment of this value with a trimmer "20 mA", turn the shaft to the initial position and adjust the value 4 mA with a trimmer "4 mA". Check the adjustment afterwards.

Unless the current is 4mA ± 80µA at the beginning of the shaft position and 20 mA ± 80µA at the end, repeat the adjustment.

$$*) I_{H1} = 16 \times I_{H0} / (I_{H0} - I_{L0})$$

I_{L0}.. Value of current at the initial rotation of shaft

I_{H0}.. Value of current at the end rotation of shaft

I_{H1}.. Calculated value of current for end rotation of shaft

Adjustment of reversing

Normal direction of travel is set-up at the factory, i.e. that current is increased with increasing lift. When adjusting the opposite direction, remove the interconnecting pieces, turn them by 90 ° and insert them back, refer to the Figure. Then inspect or, as the case may be, adjust outlet current in both positions.

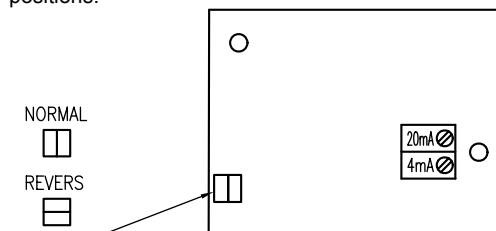

Adjustment of position control

The control is adjusted by the manufacturer to the nominal lift, inlet signal pursuant to purchase order and movement to the end position in the direction of the signal in case of its loss.

In case of changes of these parameters, proceed as follows:

A change of the inlet signal for ranges starting with zero shall be realized by changing the location of interconnecting pieces pursuant to the table:

INSTALLATION OF INTERCONNECTING PIECES::

0 to 1 V	J1, J2
0 to 10 V	J2
0 to 20 mA	J1, J3
4 to 20 mA	J1, J3

A change of the inlet signal to 4 to 20 mA or from 4 to 20 mA to signals starting with zero is realized by changing the location of interconnecting pieces pursuant to the table and follow-up calibration:

- connect the adjustable source of current or voltage signals;
- connect power supply;
- press push-buttons 1 and 2 for 5 sec., after their releasing LED diodes will start flashing concurrently (ADJUSTMENT mode);
- adjust the lower value of voltage or current on the source;
- move the servomotor by manual control to the lower position; both LEDs shall be flashing; flashing of only one LED signals reaching the end stop and a danger of overturning the position sensor; resistance value shall be increased by turning the potentiometer;
- press push-button 1 till the diode flashes (saving this position in memory);
- adjust the upper value of voltage or current on the source;
- move the servomotor by manual control to the upper position; both LEDs shall be flashing; flashing of only one LED signals reaching the end stop and a danger of overturning the position sensor; resistance value shall be decreased by turning the potentiometer;
- press push-button 2 till the diode flashes (saving this position in memory);
- press push-buttons 1 and 2 for 5 sec. (confirmation of set-up values to EEPROM memory);
- switch off and on power supply of the servomotor;
- adjust the lower value of voltage or current on the source, connect power supply and the servomotor shall move to the lower position;
- adjust the upper value of voltage or current on the source, connect power supply and the servomotor shall move to the upper position.

Warning: During the adjustment, power supply may not be interrupted; otherwise the whole procedure shall be repeated!

A change of lift or a change of range of the inlet signal within 30 % of the relevant nominal range is realized according to the procedure described in Article 4.10.2 – Installation, operation and maintenance manual, with the required values of the inlet signal and lift.

In case of a change exceeding 30%, the transmitter shall be adjusted pursuant to the paragraph about adjustment of transmitter; the inspection of adjustment of end positions is pursuant to the flashing of diodes. The inlet signal is adjusted by the computer with the use of the adjustment programme.

By means of the application of the adjustment programme, the computer, which is connected to the controller by means of the adapter, can be used for the adjustment of:

- end positions
- lower insensitivity zone 2 to 5 %
- upper insensitivity zone 2 to 5 %
- temperature protection of motor
- type of action of the controller in case the pre-set range is exceeded by 5 % (open, close, without response, movement to the end position in the direction of the signal).

It is secured by the service of the manufacturing plant or the adjustment programme and an adapter to the computer (code ANP1) can be purchased.

Adjustment of capacity transmitter with converter

The servomotors with transmitter are adjusted to the lift pursuant to the purchase order. Unless specified otherwise, it is 62 mm. In case of another lift, the adjustment is performed as follows:

- The lift is adjusted pursuant to the paragraph about adjustment of transmitter (without inspection of residue resistance).

- Before the start of adjustment of the capacity transmitter, the area shall be found out where the current value is increasing with increasing lift.
- When this area has been found out, value 4 mA is adjusted in the position CLOSED by releasing the clips and mechanical rotating of the transmitter.
- The tie-rod of the servomotor is moved to the position OPEN and value 20 mA is adjusted by turning the trimmer, the shaft of which is led to the rear side of the transmitter by 90° from the inlet clamps (not in the axis of the transmitter). Screwdriver with width 3 mm shall be used for the adjustment. The trimmer has no stoppers; it cannot be damaged by overturning.
- If correction of current 20 mA is considerable, adjustment to 4 and 20 mA shall be repeated once more pursuant to the previous paragraphs. Using narrow sectors too often is not recommended, because additional errors occur relatively more often. The most suitable sectors are from 60 to 120°.

Wires of the transmitter circuit between the outlet and the terminal board shall be inserted into an insulation tube.

COMMISSIONING

After the installation on the controlled equipment, adjustment and connection to the supply voltage, the servomotor is prepared for operation.

Warning!

A failure to comply with the instructions specified in the Installation, operation and maintenance manual will result in faulty technical parameters and/or even failures of devices without any claim for warranty repairs whatsoever.

OPERATION AND MAINTENANCE

Manual control of the servomotor can be realized according to the adjustment of the output shaft (page 3).

At the factory, the movement screw is treated with sliding paint MOLYKOTE ensuring maintenance-free continuous lubrication for the whole period of service life and additional lubrication is made with grease MOLYKOTE 165 LT. Toothed wheels and bearings are lubricated with plastic grease MOGUL LV2 M (addition of molybdenum disulphide). After one year of permanent operation, it is recommended greasing the required places with the aforesaid greases.

SPARE PARTS

Spare parts shall be delivered by the manufacturer on the basis of a previous agreement.

REPAIRS

The repairs shall be realized by the manufacturer. The device shall be sent for repair in the original or equal package without accessories.

Figure 1 Dimensional drawing - connection P2 - coupling M20x1.5, - connection P3 - coupling M16x1.5

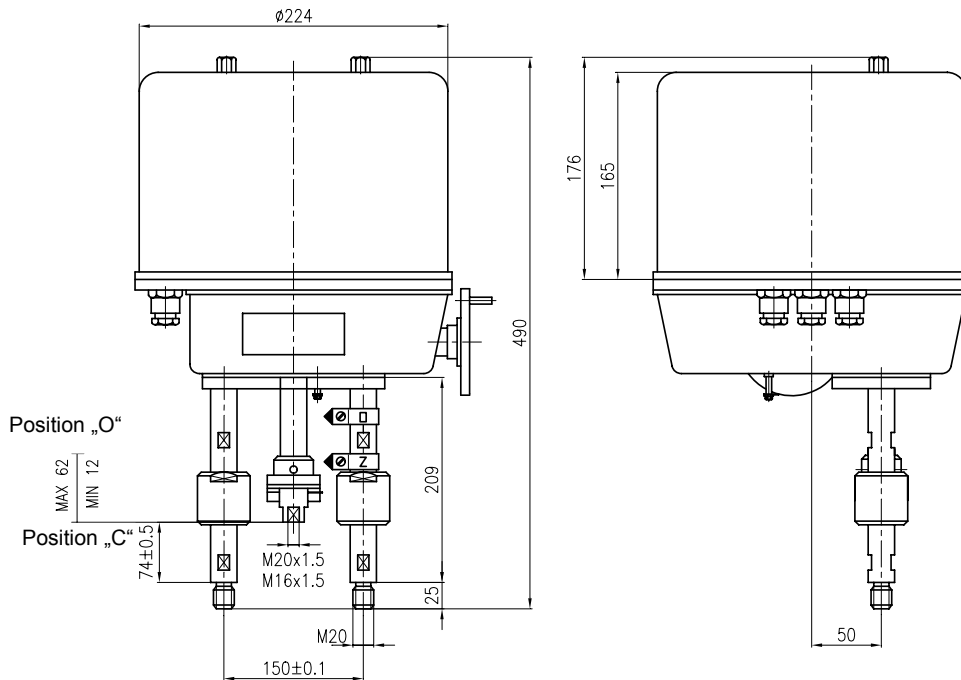

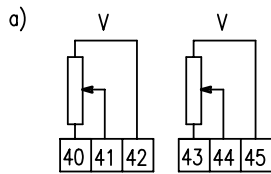

- KPO - end position switch for servomotor position O
- MO - strength switch for servomotor position "O"
- MC - strength switch for servomotor position "C"
- SO - strength signalling switch for servomotor position O
- SC - strength signalling switch for servomotor position C
- V - transmitter
- R - heating resistor
- M - motor
- T - thermal fuse
- C - condenser
- I1 - converter 4 ÷ 20 mA for two-wire connection to measuring loop (power supply directly from measured signal)
- C1 - capacity transmitter with converter 4 ÷ 20 mA

Figure 4 Connection scheme and drawing of terminal board – control 0-10 V, 0-20 mA, 4-20 mA

CONNECTION SCHEME 230 V 50 Hz

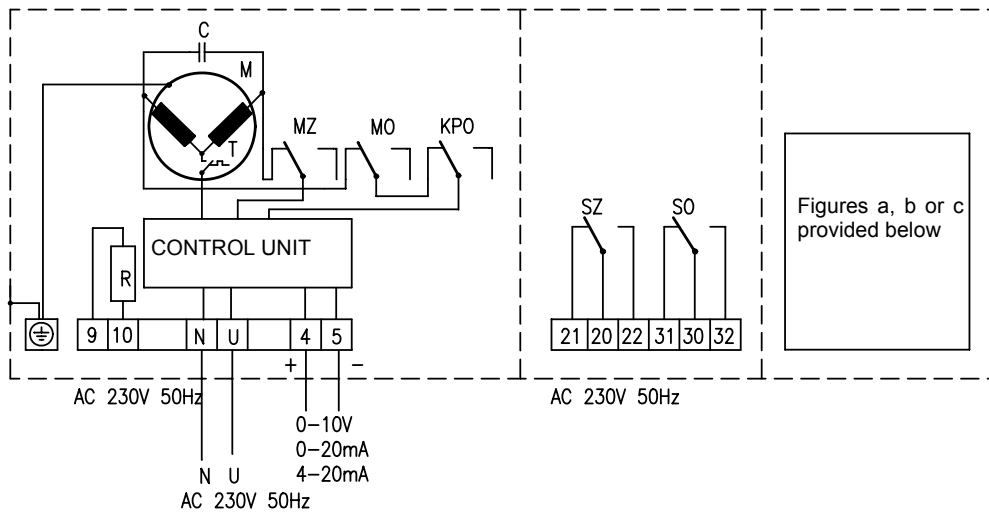

CONNECTION OF TERMINAL BOARD 24 V 50 Hz

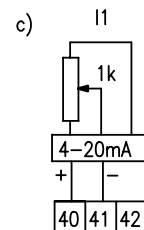
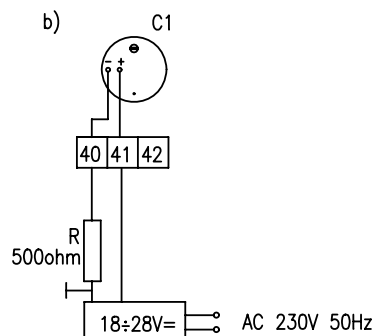
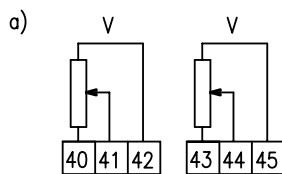
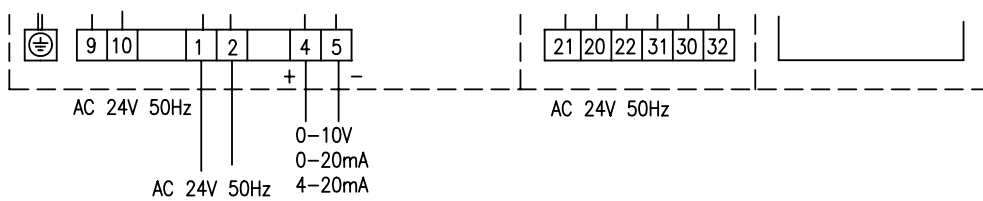

KPO	- end position switch for servomotor position O
MO	- strength switch for servomotor position "O"
MC	- strength switch for servomotor position "C"
SO	- strength signalling switch for servomotor position O
SC	- strength signalling switch for servomotor position C
V	- transmitter
R	- heating resistor
M	- motor
T	- thermal fuse
C	- condenser
I1	- converter 4 ÷ 20 mA for two-wire connection to measuring loop (power supply directly from measured signal)
C1	- capacity transmitter with converter 4 ÷ 20 mA



MMG Műszerszerviz Kft.
1036 Budapest, Dereglye u. 1.,
Tel/fax: 204-2252, Tel:203-7443
Web: www.mmg.hu, E-mail: info@mmg.hu